

REVISION RECORD

REV	ECN	DESCRIPTION	DRFT	DATE
-----	-----	-------------	------	------

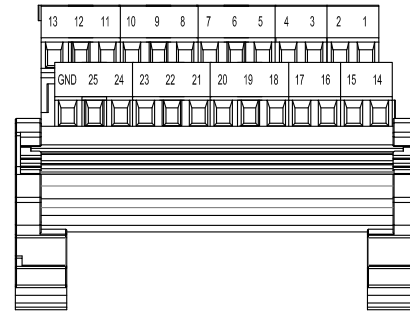
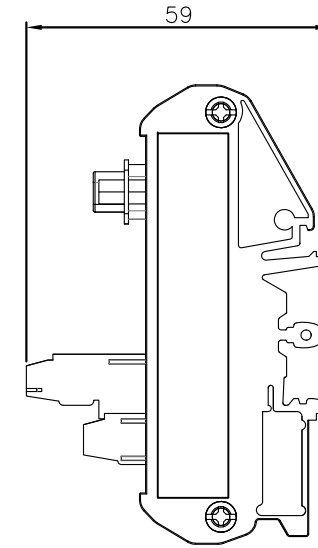
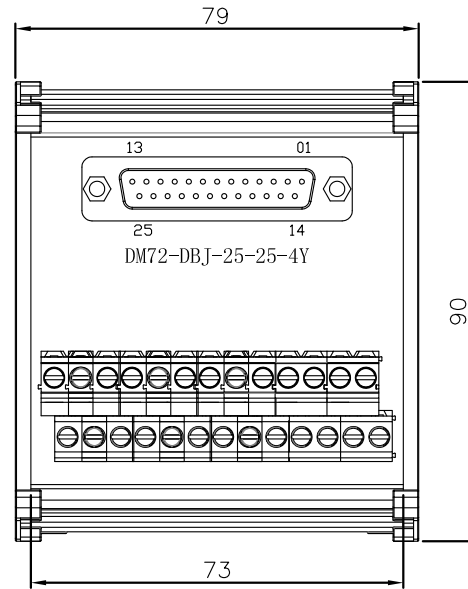

Specifications

Rated voltage	DC24V
Rated current	1A
Status display	no
Connector digits	25
Stripping Length	7mm
Terminal torque	0.4Nm (3.54Lb-In)
Input port/wire diameter	D-SUB 25P Female
Output port/wire diameter	DG500-5.08/ 1.0-2.5mm <sup>2</sup> /24-12AWG;
Temperature range	- 25℃ ~ +55℃
Installation Method	35mmDIN

DETACHED LISTS	PART NO.:	宁波高松电子有限公司 NINGBO DEGSON ELECTRICAL CO., LTD		
	APPD:	NAME: <b>DM72-DBJ-25-25-4Y-XXAH</b>		
	CHKD:			
	DRFT:	TITLE: <b>ASSEMBLY DRAWING</b>	REV	
THIRD ANGLE PROJECTION		DRAWING NO.: <b>DM72-DBJ-E03</b>	SHEET	<b>1/1</b>
		DO NOT SCALE DRAWING	SCALE	<b>1:1</b>