

未注公差/General tolerances (mm)												0.1/10	
0	>3	>6	>10	>18	>30	>50	>80	>120	>180	>250	>315		>400
~3	~6	~10	~18	~30	~50	~80	~120	~180	~250	~315	~400	~500	>500
±0.12	±0.18	±0.22	±0.26	±0.31	±0.37	±0.57	±0.80	±0.93	±1.05	±1.15	±1.60	±2.20	±2.50

Transfer or duplication of this document as well as the utilization or communication of its contents are prohibited unless authorized in writing. All rights reserved for patent, utility model or design registrations. 除专利、实用新型、外观设计、发明专利、软件著作权、集成电路布图设计专有权、商业秘密、技术秘密、其他知识产权等权利外，本公司保留对涉及发明、实用新型、外观设计、集成电路布图设计专有权、商业秘密、技术秘密、其他知识产权等权利的所有权利。

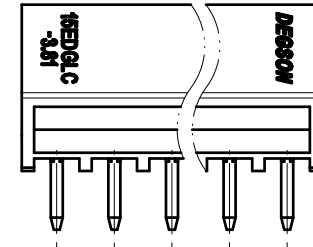
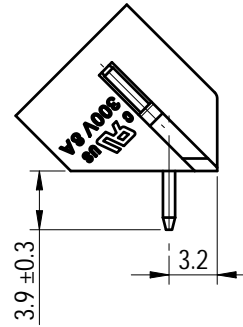
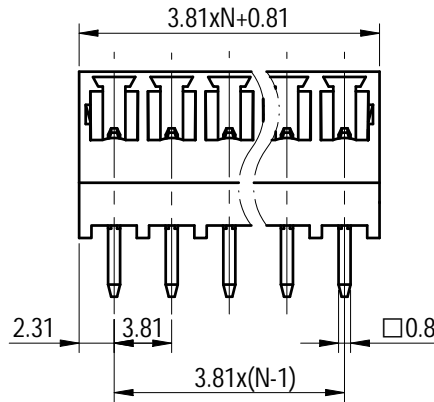
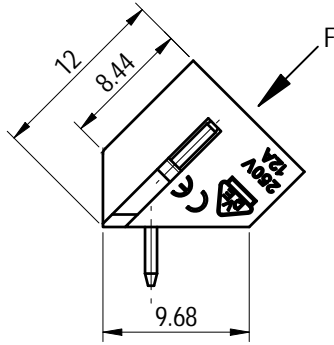
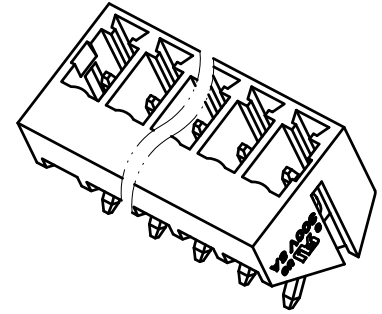
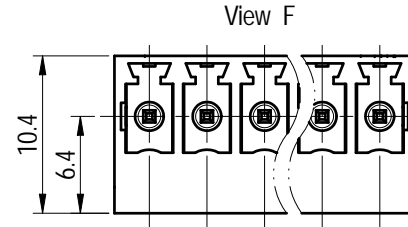
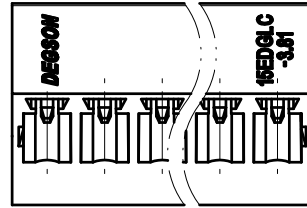

Note:
The A&Z(H) in the name means: A(H) and Z(H).

ITEM	NAME OF PART	MATERIAL	NOTES
2	Pin	Copper Alloy	Sn Plated
1	Housing	PA66	UL94V-0

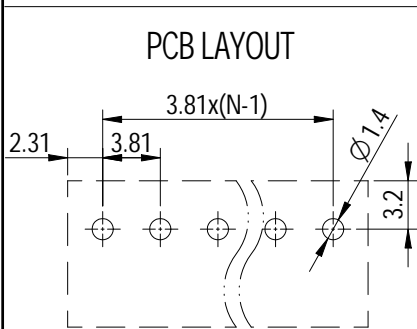

UL 标准/UL Standard:	B	C	D
额定电压/电流/Rated Voltage(V)/Current(A)	300/8	/	300/8
IEC 标准/IEC Standard:			
过压类别/Overvoltage Category/污染等级/Pollution Degree	III/3	III/2	II/2
额定电压/电流/Rated Voltage(V)/Current(A)	/	/	250/12
额定脉冲电压(KV)/Rate Impulse Voltage(KV)	/	/	2.5
间距/Pitch(mm)/线数范围/Poles	3.81/N=02~24P		
使用温度范围/Operating temperature(°C)	-40~+105		
符合RoHS环保要求/Conform to RoHS	Yes		

DEGSON

APPD: 兰春华 2022.09.07
 CHKD: 龚耀志 2022.09.06
 DRFT: 朱岳鹏 2022.09.06

MATERIAL:	SURFACE/COLOR:		
MAT NO./REV:	- / 00	MAT STATUS: 批量	
NAME	15EDGLC-3.81-XXP-1Y-00A&Z(H)		
DRAWING NO.	TYPE	DRAWING STATUS	SCALE
200029771	CUSTOMER DRAWING	已发布	2:1
SHEET	1/1		

REV	ECN	DESCRIPTION	DRFT	DATE
00			朱岳鹏	2022.09.06